

***Trinitron[®] Multimedia
Computer Display***

Operating Instructions



CPD-220VS

© 1997 by Sony Corporation

Owner's Record

The model and serial numbers are located at the rear of the unit. Record the serial number in the space provided below. Refer to these numbers whenever you call upon your dealer regarding this product.

Model No. CPD-220VS

Serial No. _____

WARNING

To prevent fire or shock hazard, do not expose the unit to rain or moisture.

Dangerously high voltages are present inside the set. Do not open the cabinet. Refer servicing to qualified personnel only.

This equipment has been tested and found to comply with the limits for a Class B digital device, pursuant to Part 15 of the FCC Rules. These limits are designed to provide reasonable protection against harmful interference in a residential installation. This equipment generates, uses, and can radiate radio frequency energy and, if not installed and used in accordance with the instructions, may cause harmful interference to radio communications. However, there is no guarantee that interference will not occur in a particular installation. If this equipment does cause harmful interference to radio or television reception, which can be determined by turning the equipment off and on, the user is encouraged to try to correct the interference by one or more of the following measures:

- Reorient or relocate the receiving antenna.
- Increase the separation between the equipment and receiver.
- Connect the equipment into an outlet on a circuit different from that to which the receiver is connected.
- Consult the dealer or an experienced radio/TV technician for help.

You are cautioned that any changes or modifications not expressly approved in this manual could void your authority to operate this equipment.

2

NOTICE

This notice is applicable for USA/Canada only.

If shipped to USA/Canada, install only a UL LISTED/CSA LABELLED power supply cord meeting the following specifications:

SPECIFICATIONS

Plug Type	Nema-Plug 5-15p
Cord	Type SVT or SJT, minimum 3 x 18 AWG
Length	Maximum 15 feet
Rating	Minimum 7 A, 125 V

NOTICE

Cette notice s'applique aux Etats-Unis et au Canada uniquement.

Si cet appareil est exporté aux Etats-Unis ou au Canada, utiliser le cordon d'alimentation portant la mention UL LISTED/CSA LABELLED et remplissant les conditions suivantes:

SPECIFICATIONS

Type de fiche	Fiche Nema 5-15 broches
Cordon	Type SVT ou SJT, minimum 3 x 18 AWG
Longueur	Maximum 15 pieds

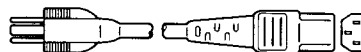

As an ENERGY STAR Partner, Sony Corporation has determined that this product meets the ENERGY STAR guidelines for energy efficiency.

Table of Contents

Introduction	4
Plug and play	4
Precautions	5
Functions of Controls	7
Getting Started	9
Installation	10
Using Your Display	12
Preset and user modes	12
Using the tilt-swivel	13
Damper wire	14
Adjustments	15
Adjusting volume	15
Adjusting the picture contrast	16
Adjusting the picture brightness	17
Adjusting the picture centering	18
Adjusting the picture size	19
Adjusting the picture rotation	20
Adjusting the pincushion	21
Setting the color temperature	22
Resetting	23
Available Features	24
Selecting Graphic Picture Enhancement (GPE)	24
Selecting Bass Boost	25
Power Saving Function	26
Specifications	27
Troubleshooting	28

Introduction

Congratulations on your purchase of a Sony Multiscan CPD-220VS display!

This display incorporates over 25 years of Sony experience with Trinitron display technology, ensuring excellent performance and outstanding reliability.

This display's wide scan range (30 – 70 kHz), together with Digital Multiscan Technology, allows it to sync to any video mode from standard VGA through VESA 1024 × 768 at 85 Hz (VESA 1280 × 1024 at 60 Hz).

In addition, its two factory preset color modes and one user adjustable color mode gives you unprecedented flexibility in matching on-screen colors to hard copy printouts.

Furthermore, it features:

- Graphic Picture Enhancement function
enabling you to create pictures for the multi-media sources.
- Bass Boost Function
enabling you to select sound quality according to the source.
- Excellent sound reproduction
via a 10 W sub-woofer and two 3.5 W tweeter speakers.

All together, CPD-220VS delivers incredible performance with the quality and support you can expect from Sony.

Plug and play

This display complies with the DDCTM1 and DDC2B which are the Display Data Channel (DDC) standards of VESA.

When a DDC1 host system is connected, the display synchronizes with the V. CLK in accordance with the VESA standards and outputs the EDID (Extended Display Identification Data) to the data line.

When a DDC2B host system is connected, the display automatically switches to DDC2B communication.

DDCTM is a trademark of Video Electronics Standard Association.

Precautions

Installation

- Prevent internal heat build-up by allowing adequate air circulation. Do not place the unit on surfaces (rugs, blankets, etc.) or near materials (curtains, draperies) that may block the ventilation holes.
- Do not install the unit near heat sources such as radiators or air ducts, nor in a place subject to direct sunlight, excessive dust, mechanical vibration or shock.
- Do not place the unit near equipment which generates magnetism, such as a converter or high voltage power lines.

Maintenance

- Clean the cabinet, glass panel and controls with a soft cloth lightly moistened with a mild detergent solution. Do not use any type of abrasive pad, scouring powder or solvent, such as alcohol or benzine.
- Do not rub, touch, or tap the surface of the screen with sharp or abrasive items, like a ball point pen or a screwdriver, as this type of contact may result in a scratched picture tube.

Transportation

- Do not discard the carton and packing materials. When transporting the unit, use these packing materials so that the unit is properly packaged.
- When carrying the unit, pay attention not to get your hands caught between the display and the tilt-swivel.

Continued to the next page →

Warning on Power Connection

- Use the supplied power cord.

For the customers in U.S.A.

If you do not do this, this display will not conform to mandatory FCC standards.

For the customers in UK.

If you use the display in UK, please use the supplied UK cable with UK plug.

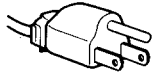

for 100 to 120 V AC

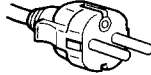

for 220 to 240 V AC

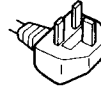

for 240 V AC only









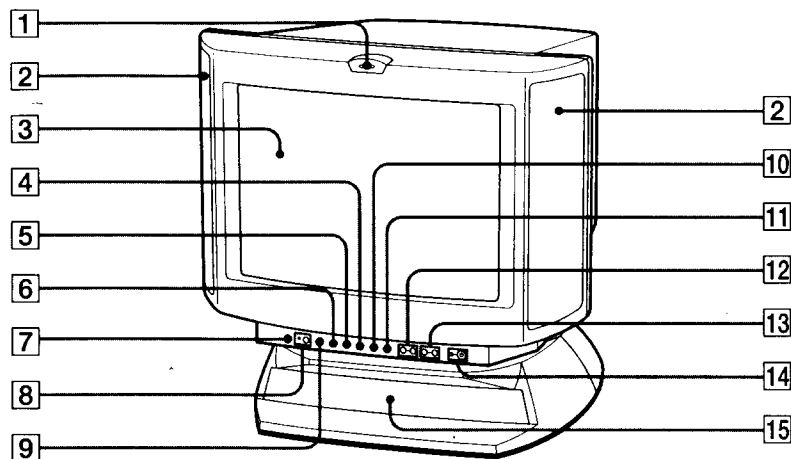

- Before disconnecting the power cord, wait at least 30 seconds after turning off the power switch to discharge static electricity from the CRT display surface.
- After the power has been turned on, the CRT is demagnetized for approximately 5 seconds. This generates a strong magnetic field around the bezel which may affect the data stored on magnetic tape or disks near the bezel. Place such magnetic recording equipment and tapes/disks at a distance from this unit.

The socket-outlet shall be installed near the equipment and shall be easily accessible.

Functions of Controls

Front



- | | | |
|----|---|---|
| 1 | Microphone | The internal microphone is turned off when an external microphone is connected. |
| 2 | Main speaker | — |
| 3 | Display | Displays OSD when adjusting. |
| 4 |  Size button | Adjusts picture size (page 19). |
| 5 |  Geometry button | Adjusts pincushion and rotation (pages 20, 21). |
| 6 |  Color temperature button | Adjusts color temperature (page 22). |
| 7 |  Reset switch | Resets adjustments to factory setting (page 23). |
| 8 |  Mute button and indicator | Mutes sound (page 16). |
| 9 |  Volume/Bass boost button | Adjusts speaker volume or selects bass boost mode (page 25). |
| 10 |  Centering button | Adjusts picture centering (page 18). |
| 11 |  Brightness/GPE button | Adjusts picture brightness or selects GPE mode (page 24). |
| 12 |  Volume +/- buttons | Adjusts speaker volume (page 15).
The default setting of the volume level is 30 %. |
| 13 |  -/+ Contrast button | Adjusts picture contrast (page 16). |
| 14 |  Power switch and indicator | Turns on and off the display. |
| 15 | Sub woofer | — |

Continued to the next page →

Rear

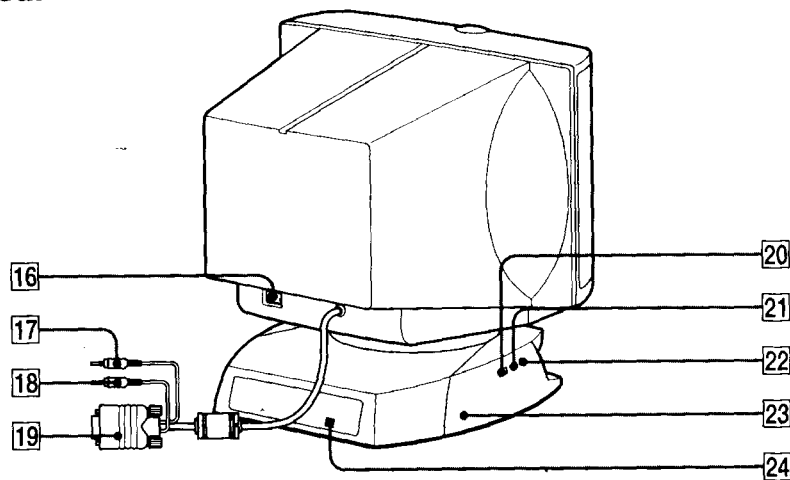

- | | | |
|-----------|----------------------------------|--|
| 16 | AC IN connector | Connect the supplied power cord (page 11). |
| 17 | Audio plug (green) | Connect to the computer's speaker output (page 10). |
| 18 | MIC plug (red) | Connect to the computer's microphone input (page 10). |
| 19 | Video signal cable (blue) | Connect to the computer's video output (page 10). |
| 20 | USB downstream connector | Connect to a USB device (page 10). |
| 21 | Microphone jack | Connect a microphone (not supplied). |
| 22 | Headphones jack | Connect headphones (not supplied). The speakers are turned off when headphones are connected. |
| 23 | Tilt-Swivel | Adjusts the angle of the display (page 13). |
| 24 | USB upstream connector | Connect to the computer's USB ports when using a USB (universal serial bus) device connected to the display (page 10). |

Getting Started

Before using this display, please make sure that the following items are included in your package:

- Multiscan CPD-220VS display (1)
- Power cord (1)
- Warranty card (1)
- Operating instruction manual (1)
- Windows 95 Monitor Information Disk and its instruction manual (1)

 **Tip**

This display will sync with any IBM or compatible system equipped with VGA¹⁾ or greater graphics capability. Although this display will sync to other platforms running at horizontal frequencies between 30 and 70 kHz, including Macintosh²⁾ and Power Macintosh systems, a cable adapter is required. Please consult Sony Technical Support for advice on which adapter is suitable for your needs.

- 1) VGA is a trademark of IBM Corporation.
- 2) Macintosh is a trademark of Apple Computer Inc.

Continued to the next page →

Installation

■ Step 1: Connect the computer

With the computer switched off, connect the video signal cable to the display (VGA) connector on your computer. If your computer supports the DDC plug-and-play standard, this connection will enable the DDC communication between the display and the computer.

Also the video signal cable is combined with audio and microphone cables. If your computer is equipped with sound capability, connect the audio and microphone plugs to appropriate jacks located on your computer.

If you use a USB (universal serial bus) device, connect the USB device to the USB downstream jack and the PC to the USB upstream jack.

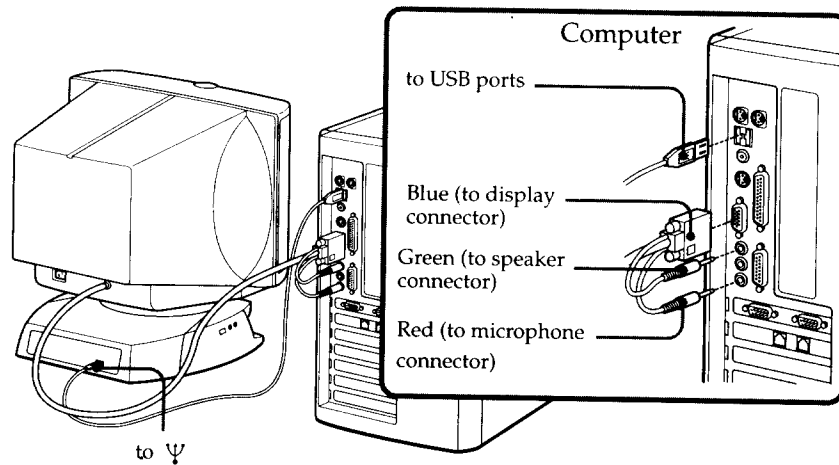

✓ **Note on handling the video signal cable**
Do not touch the pins of the video signal cable.

✓ **Note on USB ports**
USB ports are included to provide state-of-the-art technology. Until USB support is available at the operating system level, you must supply drivers to use USB devices. You can upgrade your operating system to a version that supports USB at the operating system level once a version becomes available.
See the manual that came with your USB device for more information on setting it up and using it.

■ **Step 2: Connect the power cord**

With the display switched off, connect the power cord to the display and the other end to a power outlet.

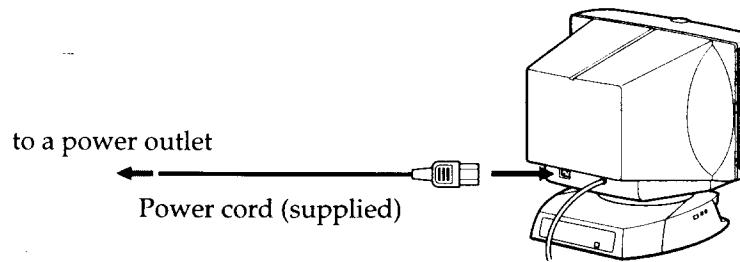

■ **Step 3: Turn on the display and computer.**

■ **Step 4: If necessary...**

Adjust the user controls according to your personal preference.

The installation of your display is complete. Enjoy your display.

Using Your Display

Preset and user modes

The Multiscan CPD-220VS display has factory preset modes for the 10 most popular industry standards for true "plug and play" capability. For less common modes, its Digital Multiscan Technology will perform all of the complex adjustments necessary to ensure a high quality picture for any timing between 30 and 70 kHz.

NO.	Resolution (dots × lines)	Horizontal Frequency	Vertical Frequency
1	640 × 400	31.5 kHz	70 Hz
2	640 × 480	31.5 kHz	60 Hz
3	640 × 480	43.3 kHz	85 Hz
4	800 × 600	37.9 kHz	60 Hz
5	800 × 600	46.9 kHz	75 Hz
6	1024 × 768	60.0 kHz	75 Hz
7	1024 × 768	68.7 kHz	85 Hz
8	1152 × 864	44.8 kHz	47 Hz (95 Hz interlace)
9	1152 × 864	54.8 kHz	60 Hz
10	1280 × 1024	64.0 kHz	60 Hz

✓ Note for Windows® 95 users

Install the new model information of the Sony computer display from "Windows 95 Monitor Information disk" into your PC. (To install the file, refer to the attached "About the Windows 95 Monitor Information Disk".)

This display complies with "VESA DDC," the standards of Plug & Play. If your PC/graphic board complies with DDC, select "Plug & Play Display (VESA DDC)" or this display's model name (CPD-220VS) as "Display type" from "Control Panel" on Windows 95. Some PC/graphic boards do not comply with DDC. Even if they comply with DDC, that may have some problems on connecting this display. In this case, select this display's model name (CPD-220VS) as "Display type" on Windows 95.

Windows® is a registered trademark of Microsoft Corporation in the United States and other countries.

✓ Note on recommended horizontal timing conditions

Horizontal sync width should be more than 1.0 μsec.
Horizontal blanking width should be more than 3.6 μsec.

■ To enter new timings

When using a video mode that is not one of the 10 factory preset modes, some fine tuning may be required to optimize the display to your preferences. Simply adjust the display according to the adjustment instructions. The adjustments will be stored automatically and recalled whenever that mode is used.

A total of 10 user-defined modes can be stored in memory. If an 11th mode is entered, it will replace the first.

Using the tilt-swivel

With the tilt-swivel, this unit can be adjusted to be viewed at your desired angle within 90° horizontally and 7° vertically.

To turn the unit vertically and horizontally, hold it at its bottom with both hands.

Pay attention not to get your hands caught between the display and the tilt-swivel.

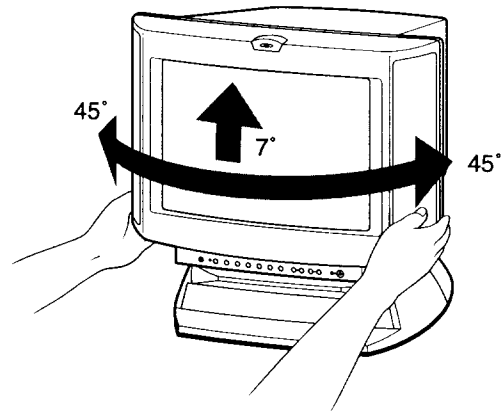

Damper wire

Using a white background, very thin horizontal lines on the screen are visible as shown below. These lines are the damper wires.

The Trinitron tube has a vertically striped Aperture Grille inside. The Aperture Grille allows more light to pass through to the screen giving the Trinitron CRT more color and brightness.

The damper wires are attached to the Aperture Grille to prevent vibration of the Aperture Grille wire so that the screen image is constantly stable.

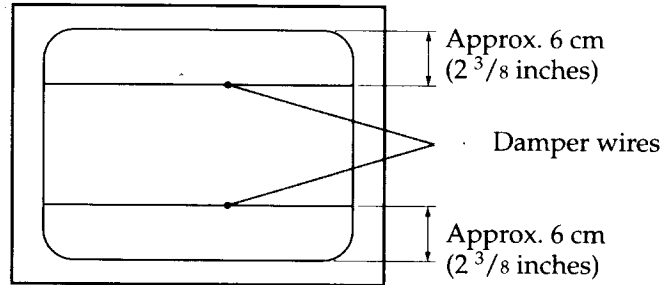

Adjustments

When one of the preset-type signals is input, no picture adjustment is necessary.

You can, however, adjust the picture to your preference by following the procedure described below.

To adjust the display, turn on the display and computer.

Select the adjustment item. You can adjust all items via the OSD (On Screen Display).

Adjustments are automatically stored in the display's memory.

Control Panel

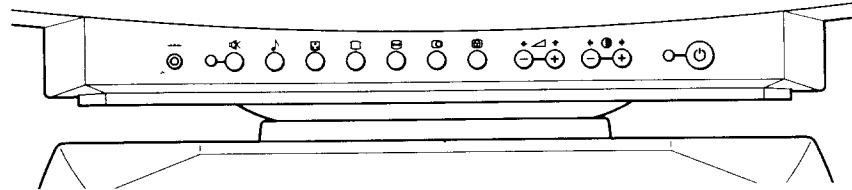

Adjusting volume

1. Press the + or - button.

The VOLUME/CONTRAST OSD appears.

The horizontal and vertical frequencies for each input signal received appear.

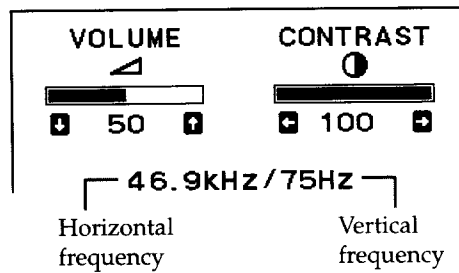
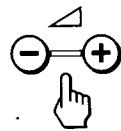

2. Press the +/- buttons to adjust volume.

+ to increase volume
- to decrease volume

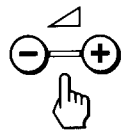



Continued to the next page →

The VOLUME/CONTRAST OSD disappears 3 seconds after you release the buttons.

 **Tips**

- The default setting of the volume level is 30 %.
- Adjust the volume while listening to the sound.
- Excessively high volume may cause howling.

■ To mute the sound

Press the  button. The  indicator lights. The light indicates mute function is in active mode.



Press again to cancel muting.

You can cancel muting also by pressing the  + button.

 **Tip**

 appears instead of  on the VOLUME/CONTRAST OSD while the sound is muted.

Adjusting the picture contrast

The adjustment data becomes the common setting for all input signals.

1. Press the  + or - button.

The VOLUME/CONTRAST OSD appears.

The horizontal and vertical frequencies for each input signal received appear.

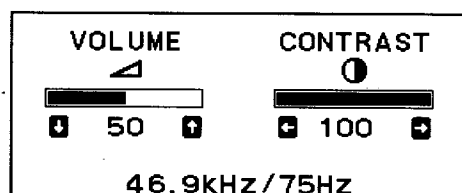
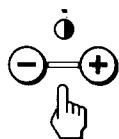

2. Press the  +/- buttons to adjust the picture contrast.
+ for more contrast
- for less contrast

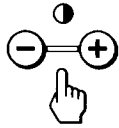



The VOLUME/CONTRAST OSD disappears 3 seconds after you release the buttons.

Adjusting the picture brightness

The adjustment data becomes the common setting for all input signals.

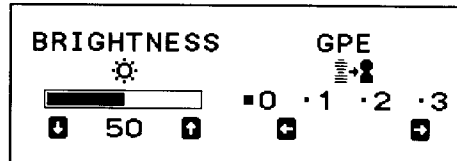
1. Press the  button.
The BRIGHTNESS/GPE OSD appears.



2. Press the  +/- buttons to adjust the picture brightness.
+ for more brightness
- for less brightness

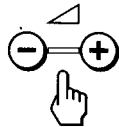

To exit the OSD

Press the  button again.

Tip

If you don't touch any buttons the OSD automatically disappears after 10 seconds.
When you want to adjust another item, press the button of the item. The OSD of the selected item appears.

Adjusting the picture centering

The adjustment data becomes the individual setting for each input signal received.

1. Press the  button.
The CENTER OSD appears.

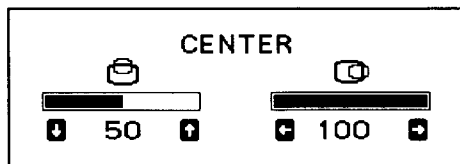

2. For vertical adjustment

Press the  +/- buttons.

+ to move up
- to move down

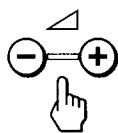

- For horizontal adjustment

Press the  +/- buttons.

+ to move right
- to move left

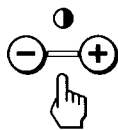

To exit the OSD

Press the  button again.

Tip

If you don't touch any buttons, the OSD automatically disappears after 10 seconds.

When you want to adjust another item, press the button of the item. The OSD of the selected item appears.

Adjusting the picture size

The adjustment data becomes the individual setting for each input signal received.

1. Press the  button.
The SIZE OSD appears.

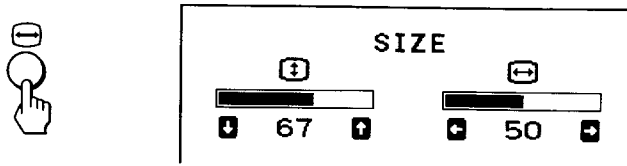

2. **For vertical adjustment**
Press the  +/- buttons.
+ to increase
- to decrease

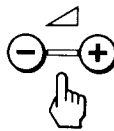

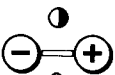
- For horizontal adjustment**
Press the  +/- buttons.
+ to increase
- to decrease

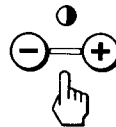

To exit the OSD

Press the  button again.

Tip

If you don't touch any buttons, the OSD automatically disappears after 10 seconds.
When you want to adjust another item, press the button of the item. The OSD of the selected item appears.

Adjusting the picture rotation

The adjustment data becomes the common setting for all input signals.

1. Press the  button.
The GEOMETRY OSD appears.

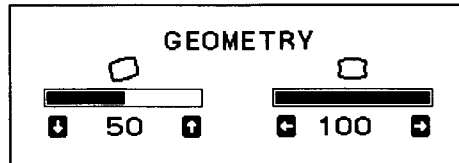

2. Press the  +/- buttons.
+ to rotate clockwise
- to rotate counterclockwise

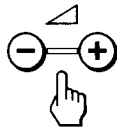

To exit the OSD

Press the  button again.

Tip

If you don't touch any buttons, the OSD automatically disappears after 10 seconds.
When you want to adjust another item, press the button of the item. The OSD of the selected item appears.

Adjusting the pincushion

The adjustment data becomes the individual setting for each input signal received.

1. Press the  button.
The GEOMETRY OSD appears.

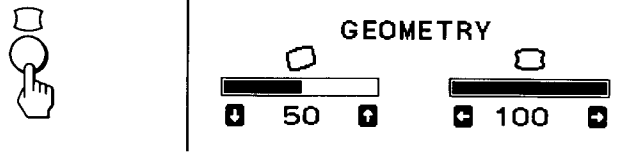

2. Press the  +/- buttons.
+ to expand the picture sides

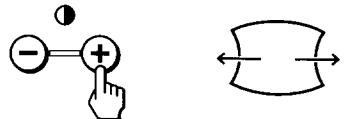

- to diminish the picture sides

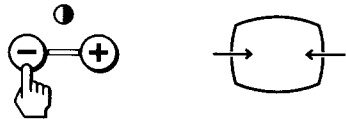

To exit the OSD

Press the  button again.

Tip

If you don't touch any buttons, the OSD automatically disappears after 10 seconds.
When you want to adjust another item, press the button of the item. The OSD of the selected item appears.



Setting the color temperature

The selected color temperature becomes the common setting for all input signals.

1. Press the  button.

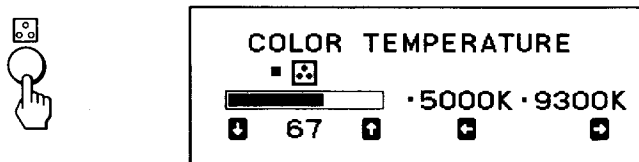
The COLOR TEMPERATURE OSD appears.



2. Adjust with the  +/- and  +/- buttons.

To select 5000K or 9300K

Press  +/- buttons.

The selected color temperature is indicated.

+ to select 9300K

- to select 5000K

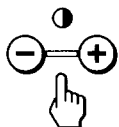

To obtain the desired color temperature between 5000K and 9300K



Press  +/- buttons.

+ for higher temperature

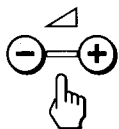
- for lower temperature



 **Tip**

The first press of  + or  button recalls the color temperature which was obtained at the last adjustment.

To exit the OSD

Press the  button again.

 **Tip**

If you don't touch any buttons, the OSD automatically disappears after 10 seconds.

When you want to adjust another item, press the button of the item. The OSD of the selected item appears.

Resetting

■ To recall the factory settings for individual adjustment item

Press the button of the adjustment item you want to recall the factory settings, and then press the **↔↔** button immediately before the OSD disappears.

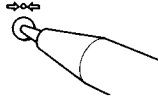

■ To recall the factory settings for the current mode

Press the **↔↔** button immediately when no OSD is shown.

■ To recall the factory settings for all modes

Press and hold the **↔↔** button for 2 seconds.
All adjustments return to the factory settings.

Available Features

Selecting Graphic Picture Enhancement (GPE)

There are 4 GPE modes from "0" through "3," and the picture is more vivid at a higher number. You can enjoy movies and games with striking visuals by enhancing the picture sharpness. Default setting is "0."

1. Press the  button.
The BRIGHTNESS/GPE OSD appears.



2. Press the  +/- buttons to select the GPE mode.
+ for higher number
- for lower number

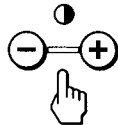

You can adjust the brightness on the same OSD by pressing the  +/- buttons.

To exit the OSD

Press the  button again.

Tip

If you don't touch any buttons, the OSD automatically disappears after 10 seconds. When you want to adjust another item, press the button of the item. The OSD of the selected item appears.

Notes on GPE mode

For text oriented applications such as word processing and spreadsheets, set the GPE mode to "0" (default setting).

GPE (Graphic Picture Enhancement) mode is reset to "0" when:

- you turn off the display
- the PC recovered from the power saving mode
- the resolution is changed

Selecting Bass Boost

There are 3 Bass Boost modes from "0" through "2," and bass is boosted more at a higher number. The factory setting is "1."

You can enjoy games and music programs with lively sound by selecting "2."

When you use the PC phone, select "0." You will be able to hear the caller's voice more easily as the high-pitched tone is reduced.

1. Press the  button.
The VOLUME/BASS BOOST OSD appears.

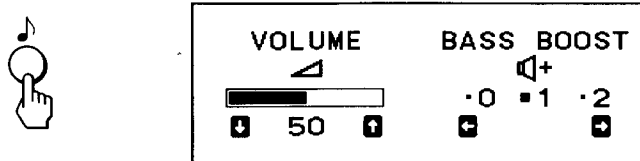

2. Press the  +/- buttons to select the BASS BOOST mode.
+ for higher number
- for lower number

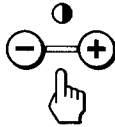

After selecting the Bass Boost mode, you can adjust the volume on the same OSD.

Press the  +/- buttons.

+ to increase volume
- to decrease volume

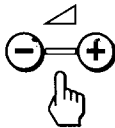

To exit the OSD

Press the  button again.

Tip

If you don't touch any buttons, the OSD automatically disappears after 10 seconds.
When you want to adjust another item, press the button of the item. The OSD of the selected item appears.

Power Saving Function

This display meets the power saving guidelines set by the International ENERGY STAR Program. It is capable of reduced power consumption when used with a computer equipped with Display Power Management Signaling (DPMS). By sensing the absence of the sync signal coming from the computer, it will reduce the power consumption as follows:

✓ CAUTION

The Power Saving function will automatically put the display into Active-off state if the power switch is turned on without any video signal input. Once the horizontal and vertical syncs are sensed, the display will automatically return to its Normal operation state.

State	Power consumption	Required resumption time	Power indicator	Speaker
1 Normal operation	150 W (max)	—	Green	On
2 Suspend (1st step of power saving)	15 W (max)	Approx. 3 sec.	Green ↔ Orange	Off
3 Active-off (2nd step of power saving)	8 W (max)	Approx. 10 sec.	Orange	Off
4 Power-off	Approx. 6 W ¹⁾	—	Off	Off

✓ Note

1) To lower the power consumption to 0 W, disconnect the power cord.

Specifications

Picture tube	0.25 mm aperture grille pitch, 17 inches measured diagonally (16.0" viewable), 90-degree deflection, AR coating
Viewable image size	Approx. 327 × 241 mm (w/h) (12 ⁷ / ₈ × 9 ¹ / ₂ inches) 16.0" viewing image
Max resolution	Horizontal: Max. 1280 dots Vertical: Max. 1024 lines
VESA standards	640 × 480 at 85 Hz 800 × 600 at 85 Hz 1024 × 768 at 85 Hz 1280 × 1024 at 60 Hz
Deflection frequency	Horizontal: 30 to 70 kHz Vertical: 50 to 120 Hz
Speaker	Left, right: 3.5 W × 2, Sub-woofer: 10 W 50 – 20 kHz
Microphones	Uni-direction, electret condenser microphone
Microphones output	Miniplug
Audio input	Stereo miniplug, input impedance 47 kΩ, input level 0.7 Vrms typical
Headphones output	Stereo minijack, 4 mW + 4 mW at 16 Ω
Microphones input	Minijack, plug-in-power
USB pass-through	Upstream × 1, downstream × 1
Controls	Contrast/Audio level/Picture enhancement/ Brightness/Bass Boost/(Audio level)/H.Size/V.Size/ Pincusion/Color temperature/Audio muting
AC input voltage/current	100 to 240 V, 50 – 60 Hz, 1.5 – 0.5 A
Dimensions	Approx. 481.5 × 483 × 427.5 mm (w/h/d) (19 × 19 ¹ / ₈ × 16 ⁷ / ₈ inches)
Mass	Approx. 22 kg (48 lb 8 oz)

Design and specifications are subject to change without notice.

Troubleshooting

This section may help you isolate a problem and as a result, eliminate the need to contact technical support, allowing continued productivity.

No picture

If the  indicator is not lit

- Check that the power cord is properly connected.
- Check that the  switch is in the "ON" position.

If the  indicator is lit in orange, or alternately in orange and green

- Check that your computer power switch is in the "ON" position.
- The display may recover when you press any key on the keyboard of the computer.
- Check that the video cable is properly connected.
- Ensure that no pins are bent or pushed in the HD15 connector of the cable.
- Check that the video card in your computer is seated completely in a proper bus slot.
- Check that the video sync signal is within that specified for the display.
- This display has a self-diagnostics function. To activate the function, turn off the computer and the display. Press and hold the  switch of the display for about 8 seconds. If the display is operating correctly, the screen will become white first and then the color bars will appear.

If the  indicator is flashing in orange

- Check that the video sync signal is specified for the display.
- There is a potential display failure. Contact Sony Technical Support.

No sound from speaker

If the  indicator is lit

- Press the  button to cancel muting.

- Check that the audio plug is properly connected.
- Adjust the volume with  +/- buttons.
- Check that the headphones are not connected.
- Check that the sound board of the computer is properly connected.
- Check that the volume control, muting, sound selector, etc. of the sound board. (See the computer's manual.)

Microphone mixing is not possible

- Check that the MIC plug is properly connected.
- Check that the sound board of the computer is properly connected.
- Check that the microphone control, sound selector, etc. of the sound board. (See the computer's manual.)

Howling (feed-back) is heard

- Decrease the volume with \triangleleft +/- buttons, or turn down the microphone input volume of the sound board.

Picture is scrambled

- Check your graphics board manual for the proper display setting on the display.
- Check this manual and confirm that the graphic mode and the frequency at which you are trying to operate is supported. Even within the proper range, some video boards may have a sync pulse that is too narrow for the display to sync correctly.

Color is not uniform

- Trip the \odot switch once to activate the Auto-degauss cycle*.

Picture is flickering

- If the refresh rate is not appropriate, the picture may flicker. Set the refresh rate of the non-interlace mode as high as possible on the computer. For details on how to set the refresh rate, consult the dealer of your computer or video board.

Screen image is not centered or sized properly

- Adjust picture centering, size, or geometry (rotation/ pincushion) on the OSD (pages 18–21).
- Some video modes do not fill the screen to the edge of the display. There is no single answer to solve the problem. There is a tendency for this problem to occur on higher refresh timings.

Picture is fuzzy

- Adjust the contrast and brightness on the OSD (pages 16, 17). Some brands of SVGA boards have an excessive video output level which creates a fuzzy picture at maximum contrast.
- The GPE setting may not be proper for the picture. Selecting a lower GPE number may improve the picture (page 24).
- Trip the \odot switch once to activate the Auto-degauss cycle*.

Picture bounces or has wavy oscillations

- Isolate and eliminate any potential sources of electric or magnetic fields. Common causes for this symptom are electric fans, fluorescent lighting, laser printers, etc.
- If you have another display close to this display, increase the distance between them to reduce interference.
- Try plugging the display into a different AC outlet, preferably on a different circuit.

Picture appears to be ghosting

- Eliminate the use of video extension cables and/or video switch boxes if this symptom occurs. Excessive cable length or weak connections can produce this symptom.

Continued to the next page →

Fine horizontal lines (wires) are visible

- These wires stabilize the vertically striped Aperture Grille. The Aperture Grille allows more light to pass through to the screen giving the Trinitron CRT more color and brightness.

Wavy or elliptical (moire) pattern is visible

- Due to the relationship between resolution, display Aperture Grille pitch and the pitch of some image patterns, certain screen backgrounds, especially gray, sometimes show moire which looks like wavy lines. This can only be eliminated by changing your desktop pattern.

Hum is heard right after the power is turned on

- When the power is turned on, the Auto-degauss cycle* is activated. While the Auto-degauss cycle is activated, a hum may be heard for about 3 seconds. This is not a malfunction.

* The Auto-degauss function demagnetizes the metal frame of the CRT to obtain a neutral field for uniform color reproduction. If a second degauss cycle is needed, allow a minimum interval of 20 minutes for the best result.

- If the problem persists, call your authorized Sony dealer from a location near you, or call Sony Technical Support at 1-888-4SONYPC (1-888-476-6972).
- Note the model name and the serial number of your display. Also note the make and name of your computer and video board.